

DUAL PRESSURE CONTROLS

Type DYS

GENERAL DESCRIPTION

- Type DYS is dual pressure controls that is integrated with over pressure protection of the high pressure side and control of low pressure side of the refrigeration unit.
- Scale plate with significantly clear visibility
- Compact and light weight

CE mark applicable (available upon request)



TYPE NUMBER SELECTION (SPECIFICATIONS)

Automatic reset type

Unit: MPa {kgf/cm²}

*1 Catalog No.	Pressure Side	Range		Differential		Factory Setting		Max. Working Pressure	Contact Function	Wt. (kg)
		Min.	Max.	*2 Min.	Max.	Off	On			
SG101 DYS-D306X3A	Low Side	-0.06 {-50cmHg}	0.6 {6}	0.06 {0.6}	0.4 {4}	0.2 {2}	0.3 {3}	1.65 {16.5}	Diagram 1	0.40
	High Side	0.8 {8}	3 {30}	Approx.0.5 fixed. {Approx.5 fixed.}		2 {20}	1.5 {15}	3.3 {33}		
SG141 DYS-D606X3A	Low Side	-0.06 {-50cmHg}	0.6 {6}	0.06 {0.6}	0.4 {4}	0.2 {2}	0.3 {3}	1.65 {16.5}	** Diagram 2	
	High Side	0.8 {8}	3 {30}	Approx.0.5 fixed. {Approx.5 fixed.}		2 {20}	1.5 {15}	3.3 {33}		

Manual reset type

Unit: MPa {kgf/cm²}

*1 Catalog No.	Pressure Side	Range		Differential		Factory Setting		Max. Working Pressure	Contact Function	Wt. (kg)
		Min.	Max.	*2 Min.	Max.	Off	On			
SG111 DYS-D306X3MA	Low Side	-0.06 {-50cmHg}	0.6 {6}	0.06 {0.6}	0.4 {4}	0.2 {2}	0.3 {3}	1.65 {16.5}	Diagram 3	0.40
	High Side	0.8 {8}	3 {30}	Automatic operation on pressure increase, and manual reset.		2 {20}	manual reset	3.3 {33}		
SG146 DYS-D606X3MA	Low Side	-0.06 {-50cmHg}	0.6 {6}	0.06 {0.6}	0.4 {4}	0.2 {2}	0.3 {3}	1.65 {16.5}	** Diagram 4	
	High Side	0.8 {8}	3 {30}	Automatic operation on pressure increase, and manual reset.		2 {20}	manual reset	3.3 {33}		

• Enclosure: IP20

*1 Standard unit display is MPa. Other unit displays are available upon request by changing "X0" portion of a catalog number.

[X0: MPa, X1: bar, X2: kgf/cm², X3: kPa, X4: lb/in², X5: psi]

*2 Indicates the average value also considering instrumental errors.

**Independent Contacts

ELECTRICAL RATINGS

Rated Amps. (A)		Rated Voltage (V)	Power Factor (cos φ)	125/250V. AC
		1	0.75	
Inductive Current	Non-Inductive Current	1	0.75	12
	Full Load	0.75	0.45	
	Locked Rotor	0.45		72

Minimum contact capacity: 50mA

CONTACT FUNCTIONS

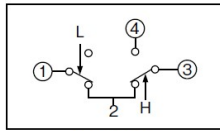

Diagram 1

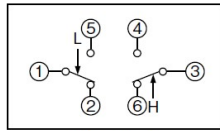

Diagram 2

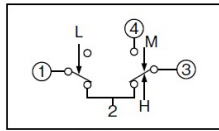

Diagram 3

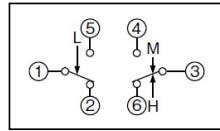
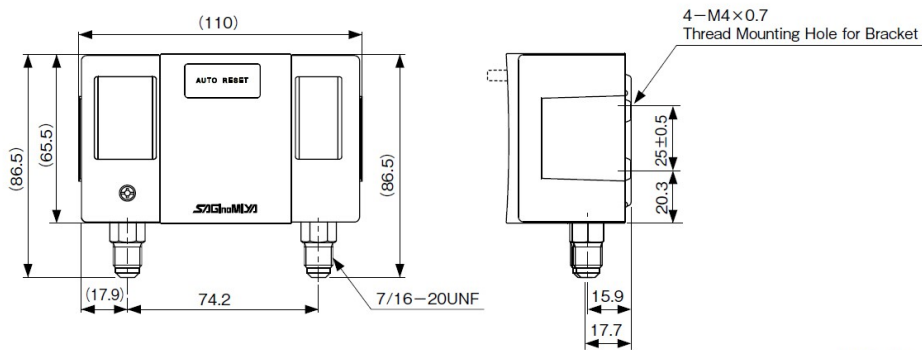
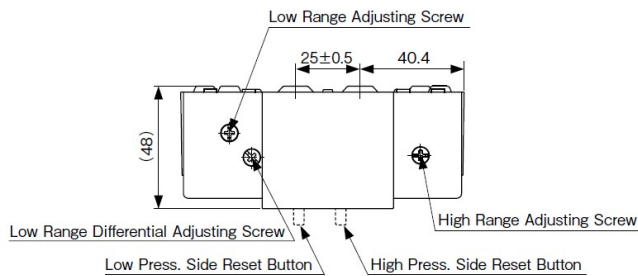

Diagram 4

L ↓: Operating direction on press. increase at Low Press. Side
 H ↑: Operating direction on press. increase at High Press. Side
 M ↓: Operating direction on manual reset

DIMENSIONS



Unit: mm

PRESSURE CONNECTIONS

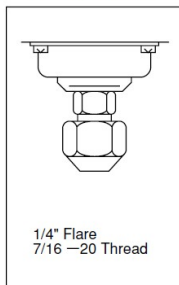

Standard